

Catálogo Banderas 2019

CONTENTS

1. Flag & Banner

1.1 National Flag	1
1.2 Outdoor Advertising Flag	3
1.3 Flag Extender	7
1.4 Outdoor Advertising Banner	8
1.5 Wall Banner	9
1.6 Street Banner	10
1.7 Indoor Advertising Banner	11
1.8 Stretch Banner	13
1.9 Fan & Sportflag	15
1.10 Golf Flag & Corner Flag	16
1.11 Carflag & Banners	17
1.12 Tableflag / Tablebanner	18
1.13 Promotion Counter	19
1.14 Tableflag / Table Cloth	20
1.15 Event Table	21
1.16 Bunting & Flag lines	23
1.17 Backpack / Backpack Flag	25
1.18 Vest	25

2. Beachflag

2.1 Beachflag Fiberglass	28
2.1.1 Beachflag Fiberglass Classic (BFC)	28
2.1.2 Beachflag Fiberglass Premium (BFC)	28
2.1.3 Indoor Beachflag	33
2.1.4 Sunny Flag (BAS)	34
2.2 Beachflag Aluminum	35

CONTENTS

2.2.2 Beachflag Alumium (BAA)	35
2.3 Beachflag Fiber-Alu (BFA)	38
3. Stylish Banner System	39
3.1 Shark Banner Wide	39
3.2 Cup Banner	39
3.3 Leaf Banner	40
3.4 Lantern Banner	40
3.5 Crystal Banner	40
4. Parasol	41
5. Tent	47
6. Display System	49
6.1 Pop Up Walls	49
6.2 Backdrop Walls	50
6.3 Easy-stand(DES)	53
6.4 X-Stand(DXS)	53
6.5 X-Feet(DXF)	53
6.6 L-stand	54
6.7 Roll Up	55
7. A-Frame	57
8. Cube Chair	59
9. Telescopic Pole (DTP)	60
9.1 Telescopic Pole Water-base(DTP-W)	60
9.2 Telescopic Pole U-feet(DTP-U)	60
10. Accessories	61
11. Fabric	63
12. Information about Data Handling and Data Submission	65

National Flag



National Flag



We manufacture National Flags of all countries and states in the world. The flags are produced on 100 % polyester fabric to ensure a long life for outdoor use.

The flags can be made in two different kinds of forms:

Vertical National Flags

Vertical Flags are printed and confectionated so that the long side is hoisted on the flagpole and the short side flies freely. Because the flag is shorter, even the breeze flies the flag freely.

Horizontal National Flags

This is the classic form for National Flags. In this case the short side is hoisted on the flagpole. The size of the flag may vary with the size of the flagpole.

Outdoor Advertising Flag



Changzhou Quality Flag Industry offers you a chance to visualize your marketing conception in a **perfect way**.

Rich and brilliant colours, **best quality** is our profession.



We produce **high quality Advertising Flags** according to your specifications.

Outdoor Advertising Flag



Our state of the art facilities for flag printing guarantee your ideas will be **implemented accurately and competently**.

Colourfully printed Advertising Flags are an amazing resource for decorative purposes. It shows your message high and builds a positive image in the mind of the viewers.



On most of our fabrics, we are able to penetrate perfectly to the reverse side of the flag.



Outdoor Advertising Flag

Outdoor Advertising Flag



Print Technology	Dye chemical screen printing Pigment screen printing Dye chemical digital printing(Direct injection) Heat transfer(Dye sublimation) UV printing
Raw Material	100% knitted polyester 100% Woven (spun) polyester 100% Nylon more than 40 different kinds of fabric available
Max Size	220x600cm (finished size)
Color Fastness	6-7 level
Color Penetration	90%-100% on most fabric
After Treatment	Fire Retardant(B1/M1 certificate) Water Repellence & Coating UV Resistance Anti-static Fluorescence Treatment

Outdoor Advertising Flag-flag extender



Make your flag always open without flag pole arm outside
Hardware can fit all type flag pole
Quick & easy for installation
Light for transportation
Competitive
Can be reused when flags are changed



front

back



Available flag width

- 100cm
- 120cm
- 150cm



outdoor Advertising Banner

Outdoor advertising banners are widely used in sports and events. Also national banners can be used with special confection at backside to fit the pole.

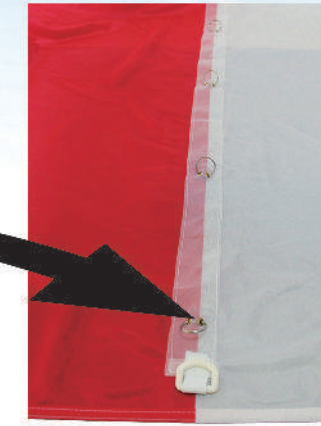

wooden bar with different plastic cap option .

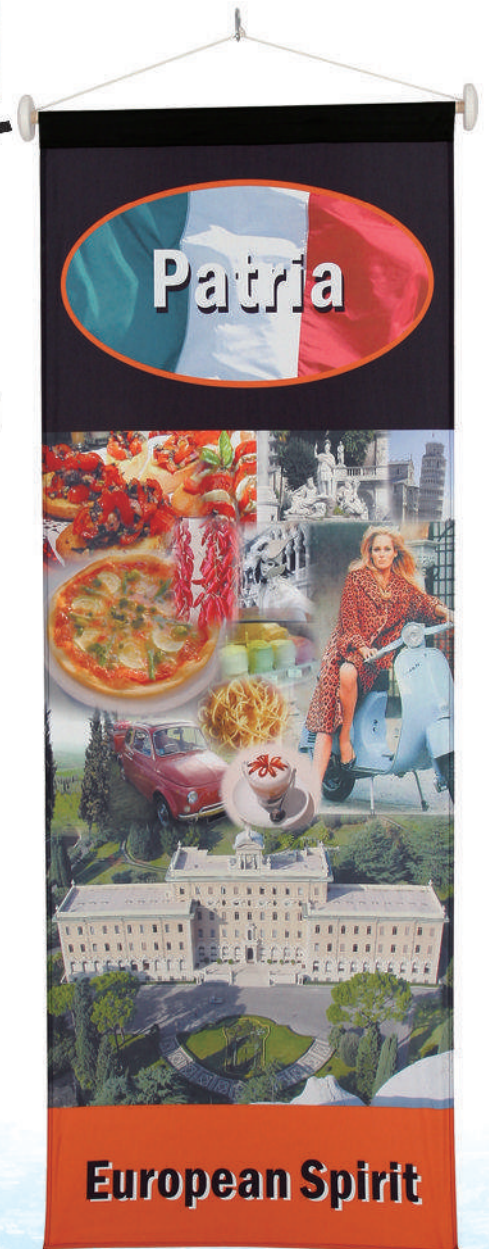

European Spirit

Wall banner

Deluxe version

Banner can be single layer or double sided

Banner shape:teardrop or customized

Banner material: 100% polyester or PVC

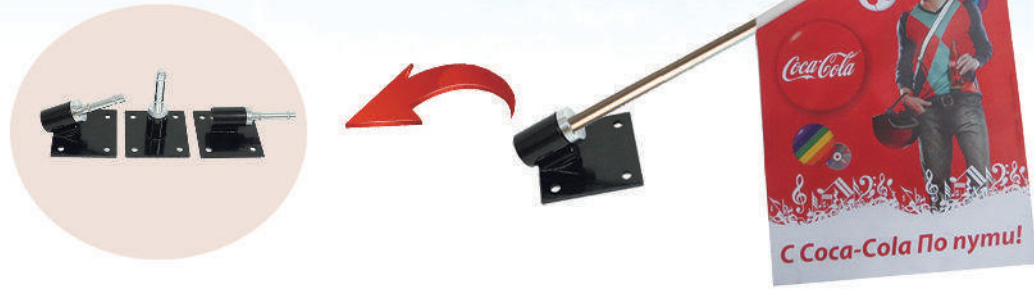

Premium version

Banner can be single layer or double sided

Banner shape:teardrop or customized

Banner material: 100% polyester or PVC

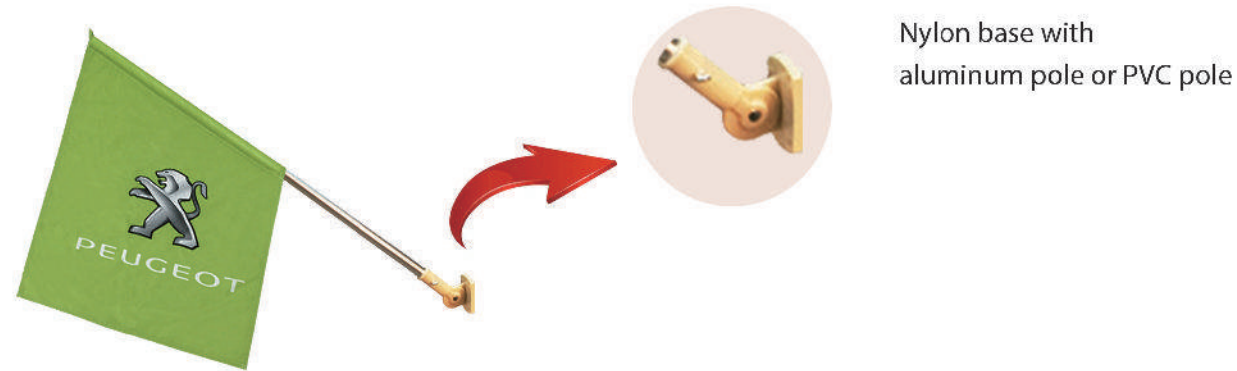

Classic version (Kiosk flags)

Banner shape:teardrop or customized

Banner material: PVC or 100% Polyester



Street Banner

Community groups and event organizers use Street Banners as a cost-effective, high-impact, place-based tool for engaging the public, promoting events, raising awareness, and communicating key messages.



Material	Polyester
	PVC
Banner Size	75 cm x 100 cm
	75 cm x 150 cm
	75 cm x 200 cm
	more height available
Printing	Screen printing
	Digital printing
Hardware	Classic
	Premium

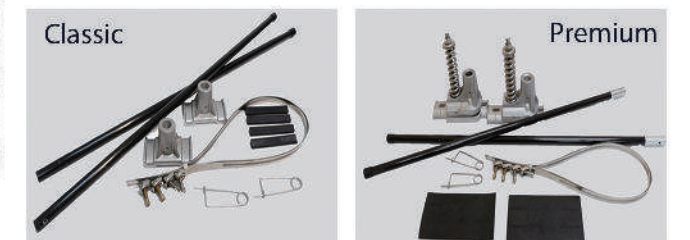

Indoor Advertising Banner

Our Fabric Banners are a great eyecatcher for your marketing conception. We offer several highest quality materials to capture the attention of your customers. Just perfect for retail displays, tradeshows and window displays.



Aluminum pole by snapping

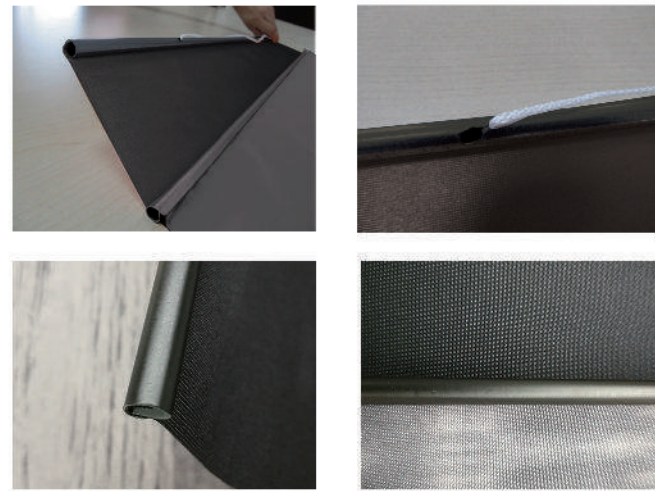

more color option
silver
white
black



Indoor Advertising Banner



Wooden bar inside



Stainless steel rod inside (3mm or 4mm)

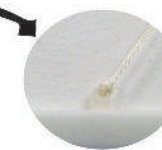

White(black) plastic clips by snapping

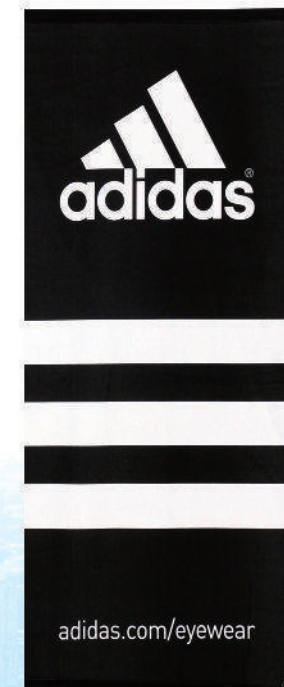
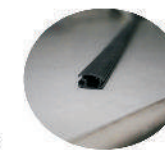

Aluminum bar inside (8mm or 10mm or 12mm)



Stretchbanner



Transparents / Stretchbanners are direct forms of advertisement which allow you to create your message directly in the eyes of the passerby.

For indoor or outdoor use they will collect attention for your product, event or company.

Ready Made can be done up to all of your specifications and wishes.

Stretchbanner





Most often seen on golf/soccer fields, the Indoor/Outdoor Corner Flags can be used on turf surfaces and are versatile enough for using in other sports or activities through your school or rec center. All kinds of 100% polyester fabric available, double-sided visible, easy for seeing.

Golf Flag



Corner Flag

With full set hardware assembled, tube, iron spike, or round base for option



Multiple shapes and sizes for choosing
Various Customized designs

Golf flag packing list

carton size(cm)		pcs/ctn	N.W.	G.W.	20' container	40' container
flag 35x48	55x36x28	150	12.4kg	13.4kg	70000pcs	142500pcs

Corner flag accessories

carton size(cm)		pcs/ctn	N.W.	G.W.	20' container	40' container
Half-round water feet	79x51x52	50	13.4kg	14.4kg	6666pcs	13570pcs
Spike	34x29x29	50	19.7kg	20.7kg	36268pcs	84240pcs
Pole	153x27x28	100	6.4kg	7.4kg	23333pcs	47500pcs

Car Flags & Banners



Easy installed in seconds, made of proven flag fabrics.
 Our Carflags come completely with flagholder.
 No additional hardware is needed.
 In all dimensions, forms and variations.
 We fulfill all wishes.
 Available as Classic or Premium system.

<p>Car window Teardrop size: 26 cm x 60 cm</p>	<p>other base options</p> <p>clip base</p> <p>magnetic base</p> <p>suction base</p>	<p>pole with banner: 110g/set pole : 96g 38x30x35cm 140pcs/ctn N/W: 15.4KGS G/W: 16.1KGS</p>
<p>Flag pole classic 45cm height/ 26g</p>		<p>Pole with fanflag packing 96x28x37cm 400pcs/ctn G/W: 20.2KGS</p>
<p>Flag pole premium 55cm height/69g</p>		<p>Pole with fanflag packing 122x30x38cm 200pcs/ctn G/W: 23.2KGS Volume weight: 27.8KGS</p>

Tableflag/Table banner

In all dimensions, forms and variations. We fulfill all wishes

<p>Table Banner customization</p>	<p>Table Beach Banner silver metal base</p>		<p>Table Banner TS101SB silver metal base</p>
<p>Table Flag TS405MF silver pole and marble base</p>	<p>Table Banner TS101GB gold pole and metal base</p>	<p>Table Banner TS301MB gold pole and marble base</p>	<p>Table Flag TS101SF silver pole and metal base</p>
<p>Table Flag TS101GF gold pole and metal base</p>	<p>Table Flag TS401MF silver pole with marble base</p>	<p>Table Flag TS301MF silver pole with marble base</p>	<p>Table Flag TS402MF silver pole with marble base</p>



Promotion Counter



Name	Round Bar Counter	Square Bar Counter
Fabric	Display Elastic 260g	
Frame size(cm)	70/50x100	80x50/60x40x100
Graphic size(cm)	216x113	241x115
Weight(kg)	14	10
Packing size (cm)	77x12x78	87x12x59

Square Bar Counter



Round Bar Counter



Tablecover/Table cloth

Standard sizes for 4', 6' and 8' table
Customized sizes are also available

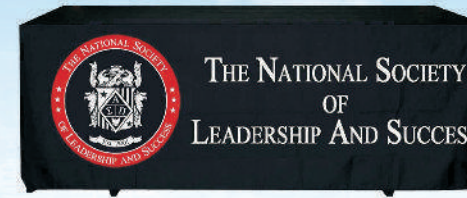

Two kinds of finishing for the edges



double stitch

loop stitch

Fabric Recommended	100% polyester Display 200g
	100% polyester Display 160g
	100% polyester Display 130g
	100% polyester Display 110g
After Treatment	Fire Resistance(B1 certificate)
Size	customization
Color Fastness	7 or up level

Event Table



with umbrella hole



Event Table Cover



Applications: Ideal for all kinds of Promotion Events, Exhibitions, Festivals, Celebrations and so on!
Cover Material: Display Elastic 260gsm/ m²
With printing of your designs!
3 Sizes Available: Diameter 60 cm / 70 cm / 80 cm!
with umbrella hole



Bunting & Flag lines

Bunting & Flagline
 Customized length and size
 Screen & digital printing

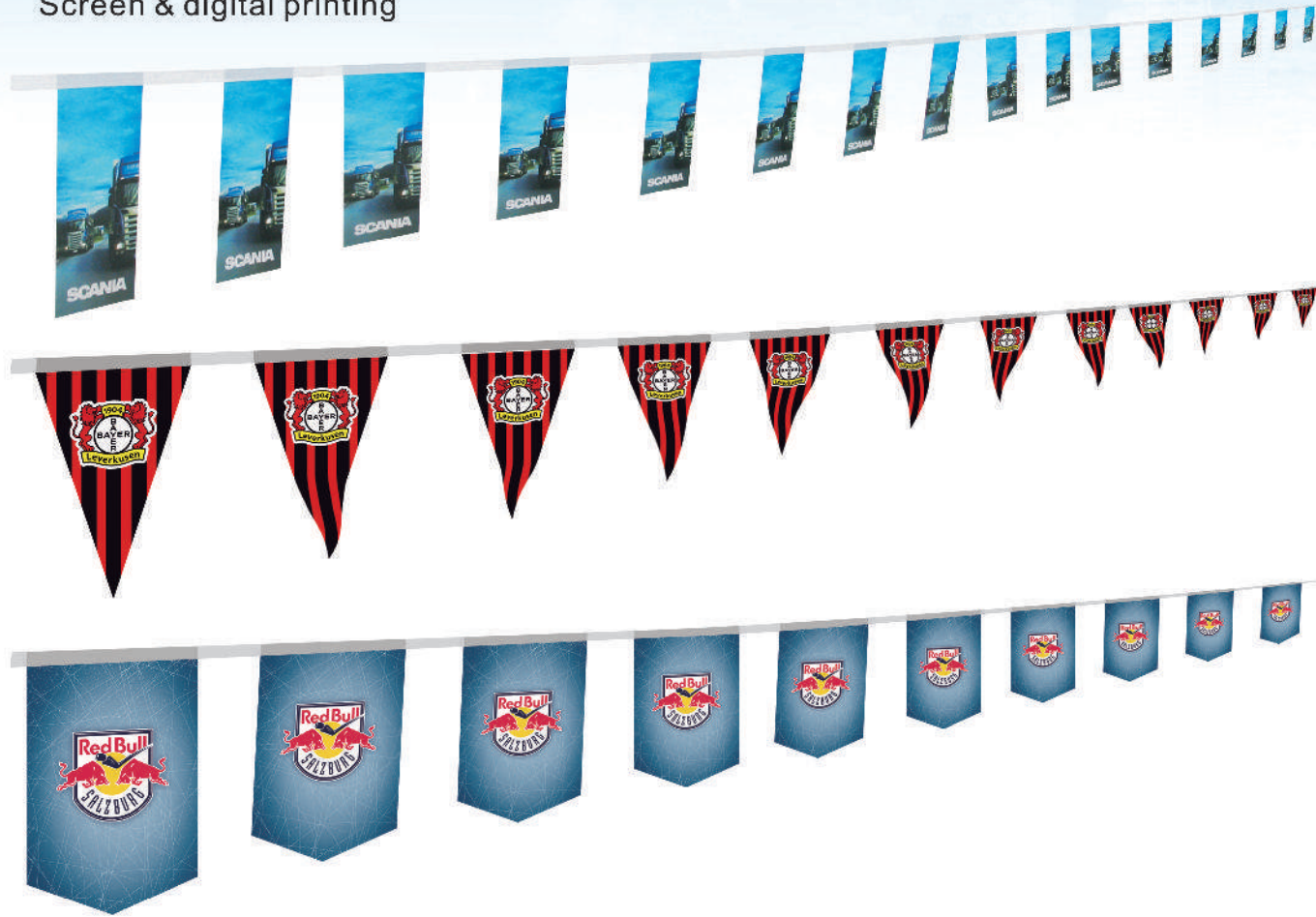

Fabric Recommended	stormflag 110g 100% knitted polyester / fanflag 80g100% spun polyester
Size	customization
Color Fastness	7 or up level

Backpack/Backpackflag

spare part	picture & material		example
bag	<p>nylon</p>		
pole	<p>fiberglass reinforced plastics</p>		
Movable advertisement Easy to catch the eyes Easy to carry Screen & digital printing			
backpack templates	A	B	C
	<p>5cm flat</p> <p>47x110cm</p>	<p>6cm flat</p> <p>55x120cm</p>	<p>5cm flat</p> <p>45x65cm</p>
packing	Packing Carton size: 70x54x28cm 10sets/ctn One set hardware N/W:1.08kgs Gross weight: 11.6kgs Volume weight: 21.2kgs		

Customized colors, logos and sizes.
 Multiple materials for choice.
 Wide usages for sports, construction, airport, road traffic,
 workshop and so on.



kid size	38X46cm
S	42x56cm
M	51x64cm
L	60x71cm
XL	70x80cm

Color Display



Fabric



Process design



Collarband Design



Process design



Collarband Design

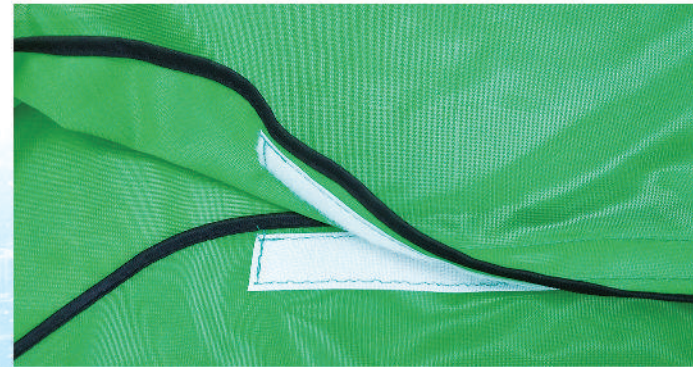

Process design



Beachflag

Beachflag Fiberglass-Classic(BFC)

Classical beachflags are a very unique and eye-catching marketing tool. The system can be easily assembled in a few seconds to catch your audience attention.

We offer many kinds of sizes and shapes. All shapes accept the same hardware, so there is no need to purchase a new hardware when a new shape is needed.

Classical beachflags come with delicate aluminium and fiberglass hardware.







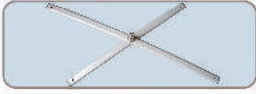

Beachflag

Beachflag Fiberglass-Classic(BFC)

Patent Numbers: 200530082680.8, 200520070917.5, 200530082681.2



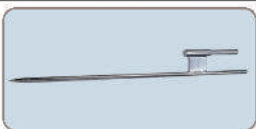



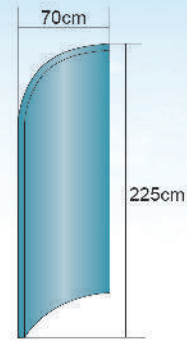
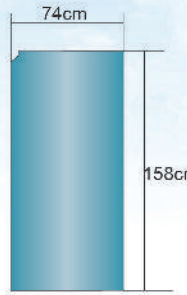
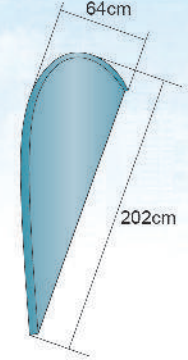
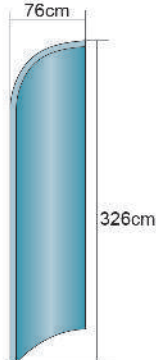
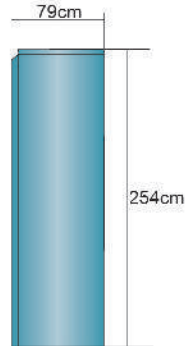
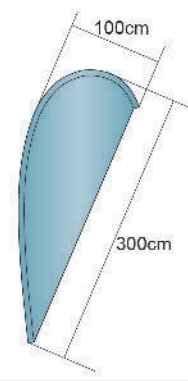
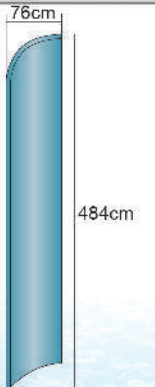
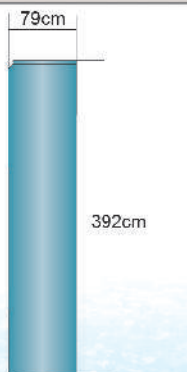
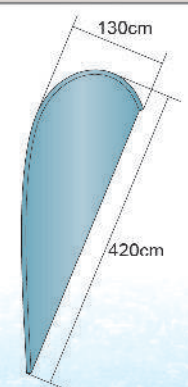

Shape	A	B	C
Sketch 3 fiberglass pole segments Polesize 324cm			
Flag Size	55 cm x 261 cm	55 cm x 261 cm	55 cm x 261 cm
Poles	3 fiberglass pole segments Polesize 324cm		
Sketch 3 fiberglass pole segments Polesize 380cm			
Flag Size	65 cm x 316 cm	65 cm x 316 cm	65 cm x 316 cm
Poles	3 fiberglass pole segments Polesize 380cm		
Sketch 4 fiberglass pole segments Polesize 508cm			
Flag Size	80 cm x 431 cm	80 cm x 431 cm	80 cm x 431 cm
Poles	4 fiberglass pole segments Polesize 508cm		
Sketch 5 fiberglass pole segments Polesize 607cm			
Flag Size	90 cm x 531 cm	90 cm x 531 cm	90 cm x 531 cm
Poles	5 fiberglass pole segments Polesize 607cm		

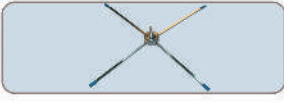
Patent Numbers: 200530082680.8, 200520070917.5, 200530082681.2				
Model No.	Spare Part			
BFC-P322 BFC-P382 BFC-P506 BFC-P607	Pole			
BFC-P322 BFC-P382 BFC-P506 BFC-P607	Cross base			
BFC-P322 BFC-P382 BFC-P506 BFC-P607	Ground Screw			
BFC-SP8 BFC-SP15 BFC-SP16	Steel Plate			
BFC-W1	Water bag			
BFC-BP2	Premium bag			
BFC-BP1	Classic transport bag			
BF-R1	Ground spike with classic rotator			
Packing information				
full set	Carton size(cm)	weight/pc(KG)	PCS/CTN	G.W./CTN(KG)
324cm pole,ground screw,cross base, water bag and classic carry bag	146x35x20	3.16	8	27.28
380cm pole,ground screw,cross base, water bag and classic carry bag	146x35x20	3.35	8	28.8
508cm pole,ground screw,cross base, water bag and classic carry bag	146x35x20	3.56	8	30.48
607cm pole,ground screw,cross base, water bag and classic carry bag	146x35x20	3.78	8	32.24

Professional design for strongest stability
All different stands are common used for all poles in different length
Easy to carry

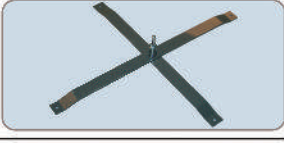

Patent Numbers: 200530082680.8, 200520070917.5, 200530082681.2			
Shape	A	B	C
Small size (assembled Pole size 3.12m) 3+1 burls			
Flag Size	70 cm x 225 cm	74 cm x 158 cm	64 cm x 202 cm
Poles	3+1 fiberglass pole segments		
Shape	A	B	C
Middle size (assembled Pole size 4.28m) 3+1 burls			
Flag Size	76 cm x 326 cm	79 cm x 254 cm	100 cm x 300 cm
Poles	3+1 fiberglass pole segments		
Shape	A	B	C
Large size (assembled Pole size 5.67m) 4+1 burls			
Flag Size	76 cm x 484 cm	79 cm x 392 cm	130 cm x 420 cm
Poles	4+1 fiberglass pole segments		

Patent Numbers: 200530082680.8, 200520070917.5, 200530082681.2				
Model No.	Spare Part			
BFP-P312 BFP-P428 BFP-P567	Pole			
BFP-SC1	Premium Cross base			
BFP-ST1	Tyre base			
BFP-SP1	Steel Plate			
BF-W	Water bag			
BFP-BP1	Premium bag			
BFP-SG2	Ground spike			
BFP-SC2	Fixed cross base			
BFP-SC3	Classical cross base Premium rotator			
Packing information - Full set				
Description	Carton size(cm)	weight/pc(KG)	PCS/CTN	G.W./CTN(KG)
A set: including 428cm pole, fixed crossbase and transport bag	155x30x15	4.9	5	25.5
B Set: including 428cm pole, Premium cross base, water bag and transport bag	155x30x15	4.48	5	23.4
C set: including 428cm pole, tyre base and transport bag	155x30x15	3.48	5	18.4
D set: including 428cm pole, ground spike and transport bag	155x30x15	2	5	11

Indoor Beachflag-Decowing

Indoor beachflags are specially designed for internal advertising purpose. It is lightweight, portable and can be built up in minutes. It can be used in various indoor occasions with different flag shapes for option.

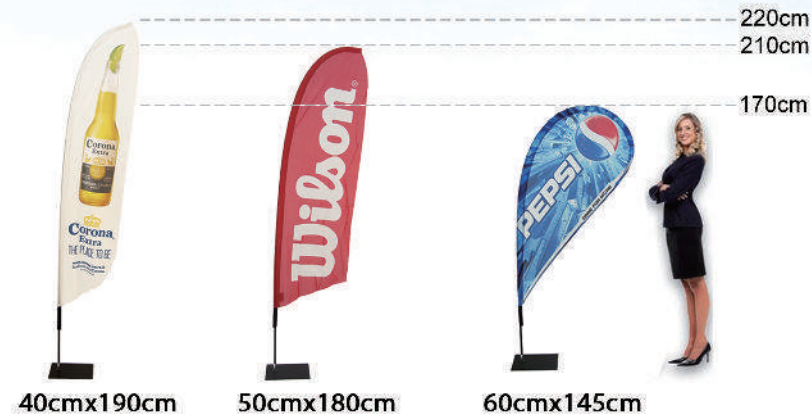

Patent Numbers: 200530082680.8, 200520070917.5, 200530082681.2				
Shape	Classical Deco wing long	Classical Deco wing big	Classical Deco banner	
Sketch				
Flag Size	40 cm x 190 cm	50 cm x 180 cm	60 cm x 145 cm	
Poles	2 fiberglass pole segments Polesize 240cm			
Packing information				
full set	Carton size(cm)	weight/pc(KG)	PCS/CTN	G.W./CTN(KG)
deco wing (2.4 m pole and metal plate base with classic carry bag)	105x30x20	1.28	15	20.7

Beachflag-Sunny Flag(BAS)



Carton Size (cm)	pcs/ctn	N.W.(kg)	G.W.(kg)	20' container	40' Container
31.5x7x90	1	2.8	3.8	1260pcs	2520pcs

Beachflag Aluminum(BAA)

height is adjustable,
can fit all BFP stands.

Very strong pole can hold
double sides flags(3 layers)



Beachflag Aluminum(BAA)

Shape	A	B	C
Small size S-PW Total height:285cm			
Flag size	102cmx240cm		
poles	assembled with BAA-PW 4 burls		

Shape	A	B	C
Middle size M-PF Total height:418cm			
Flag size	83cmx375cm		
poles	assembled with BAA-PF 5 burls		

Shape	A	B	C
Small size S-PF Total height:308cm			
Flag size	83cmx260cm		
poles	assembled with BAA-PF 4 burls		

Shape	A	B	C
Middle size M-PW total height:395cm			
Flag size	102cmx355cm		
poles	assembled with BAA-PW 5 burls		

Beachflag Aluminum(BAA)

Beachflag Beachflag Fiber-Alu (BFA)

Shape	A	B	C
Large size L-PF Total height:528cm			
Flag size	83cmx490cm		
poles	assembled with BAA-PF 6 burls		

Shape	A	B	C
Large size L-PW Total height:505cm			
Flag size	102cmx470cm		
poles	assembled with BAA-PW 6 burls		

With transport bag 128cm  BASH-SP Steel plate 

Can fit all BFP stands  BASH-SC foldable feet 

Type	Carton Size (cm)	pcs/ctn	N.W.(kg)	G.W.(kg)	20' container	40' Container
small	146x35x20	5	23.4	24.4	1370	2838
middle	146x35x25	5	25.3	26.3	1094	2266
large	146x35x25	4	21.75	22.75	875	1813

Beachflag Fiber-Alu(BFA)



Fiberglass+Aluminium Pole Components

Can fit all BFP stands



	S	M	L
BFA-PW			
	108x255	108x353	108x460
BFA-PF			
	70x228	70x338	70x448

Type	Carton Size (cm)	pcs/ctn	N.W.(kg)	G.W.(kg)	20' container	40' Container
small	122x28x20	30	16.7	17.7	12000	22260
middle	122x28x20	20	15.8	16.8	8000	14840
large	122x28x20	20	21	22	8000	14840

	Cup Banner	Shark Banner Wide
Set components		
	<p>Cup Banner</p> <p>Display height: 308cm / 243cm</p> <p>Banner size: 119x200cm / 68x135cm</p> <p>10sets/ctn</p> <p>Carton size: 156x17x14cm</p> <p>G/W: 15.5KGS</p>	<p>Shark Banner Wide</p> <p>Display height: 275cm / 232cm</p> <p>Banner size: 95x234cm / 92x191cm</p> <p>10sets/ctn</p> <p>Carton size: 126x26x16cm</p> <p>G/W: 15KGS</p>
Measurements		

	Leaf Banner	Lantern Banner	Crystal Banner
Set components			
	<p>Leaf Banner</p> <p>Display height: 284cm</p> <p>Banner size: 87x256cm</p> <p>10sets/ctn</p> <p>Carton size: 156x17x14cm</p> <p>G/W: 15KGS</p>	<p>Lantern Banner</p> <p>Display height: 230cm</p> <p>Banner size: 71x91x140cm</p> <p>10sets/ctn</p> <p>Carton size: 159x27x27cm</p> <p>15KGS</p> <p>Volume weight: 23.2KGS</p>	<p>Crystal Banner</p> <p>Display height: 259cm</p> <p>Banner size: 104x167cm</p> <p>10sets/ctn</p> <p>Carton size: 159x27x27cm</p> <p>15KGS</p> <p>Volume weight: 23.2KGS</p>
Measurements			

Sun Umbrellas in different dimensions, forms and colors.
Custom printed advertising umbrellas are an effective marketing tool.



We deliver from 1.5 meters up to 4 meters diameter. The Motive can be produced through dye printing or pigment printing - in all imaginable colour combinations.

The Sun Umbrellas come with complete accessories. We offer metal or plastic pole feet in different forms and colors, as poles in different sizes, forms and colors.



Parasol

We offer all kinds of parasols.

Size:180cm, 200cm, 250cm, 300cm, 350cm, 400cm

Shape:square/round

Segment:1/2/4/8

Water proof coating is available



Parasol



Packing	
dia1.8m with frame	dia2.0m with frame
In carton:125x25x20cm 2.3kg/set,10 sets/carton G.W:23kg/carton N.W:22kg/carton In 20' container:4600pcs,460 cartons In 40' container:9200pcs,920cartons	In carton:140x25x20cm 2.6kg/set,10 sets/carton G.W:26kg/carton N.W:25kg/carton In 20' container:4000pcs,400 cartons In 40' container:8000pcs,800 cartons
3.0mx3.0m	3.5mx3.5m
In carton:55x36x28cm 3.2kg/pcs,4pcs/carton G.W:12.8kg/carton N.W:11.8kg/carton In 20' container:2000pcs,500 cartons in 40' container:4000pcs,1000 cartons	In carton:55x36x28cm 4kg/pcs,4pcs/carton G.W:16kg/carton N.W:15kg/carton In 20' container:2000pcs,500 cartons in 40' container:4000pcs,1000 cartons

Parasol-Template

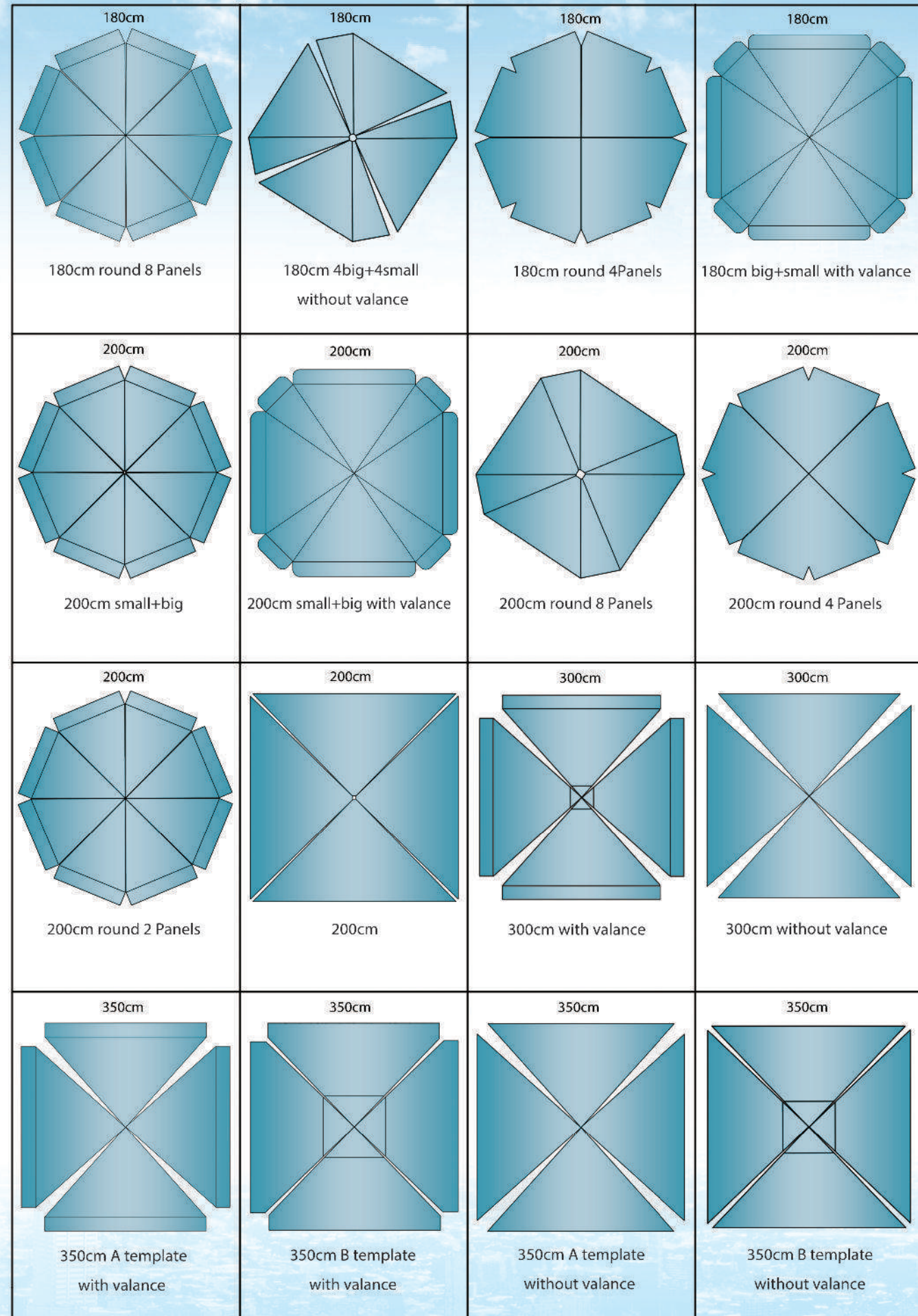

Tent

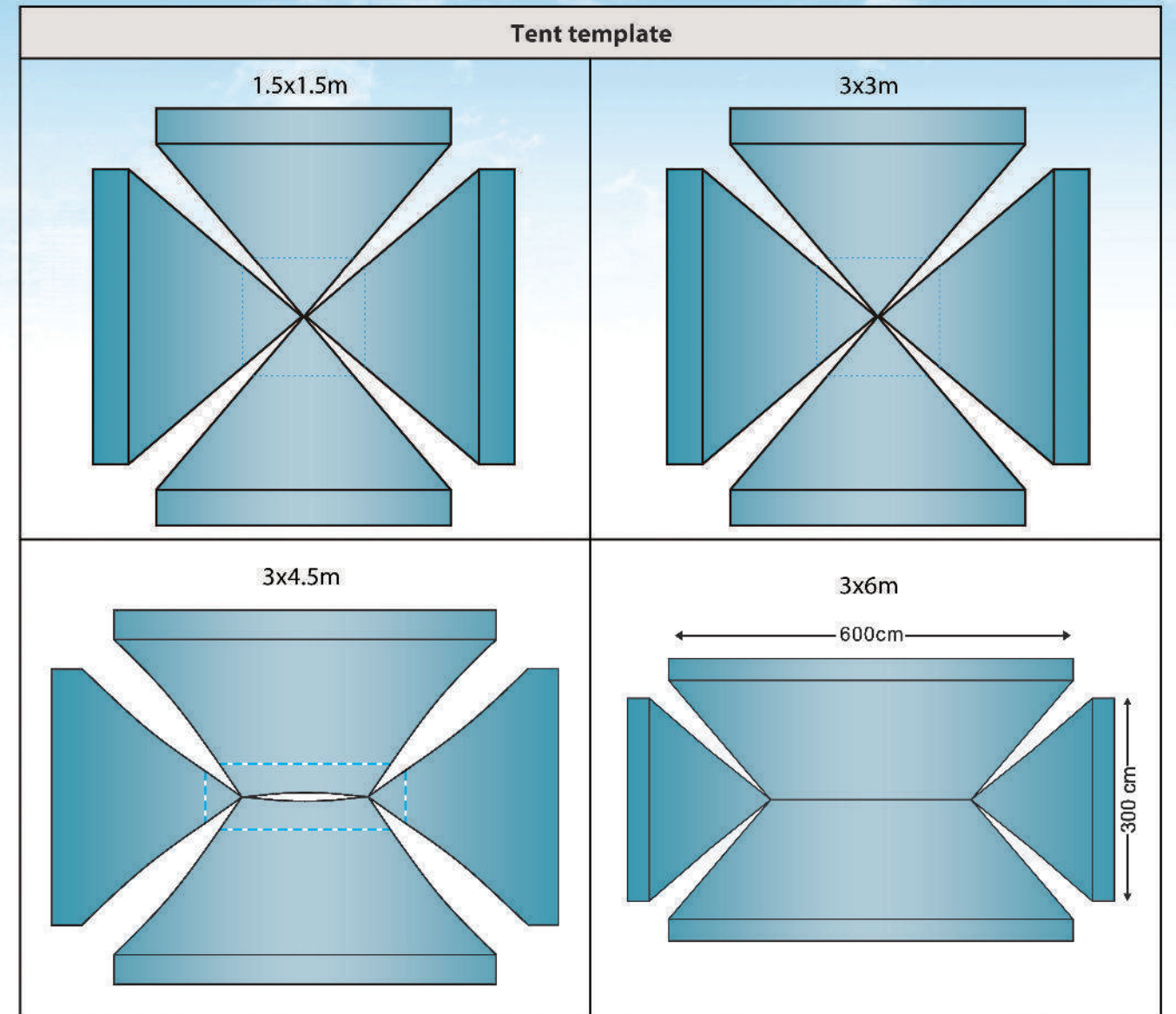

Tent frame						
	carton size(cm)	pcs/ctn	N.W.	G.W.	20' container	40' container
3x3m	158x26x26	1	17.5kg	18kg	216pcs	480pcs
3x4.5m	158x34x26	1	22.7kg	23.2kg	162pcs	360pcs
3x6m	158x45x26	1	29.9kg	30.4kg	120pcs	266pcs

Carry bag						
	carton size(cm)	pcs/ctn	N.W.	G.W.	20' container	40' container
3x3m	40x38x15	1	2.7kg	3.2kg	925pcs	2000pcs
3x4.5m	49x38x15	1	5.3kg	5.8kg	740pcs	1600pcs
3x6m	50x38x15	1	6.9kg	7.4kg	740pcs	1600pcs

Tent roof						
	carton size(cm)	pcs/ctn	N.W.	G.W.	20' container	40' container
3x3m	55x36x28	4	14.4kg	15kg	1400pcs	2940pcs
3x4.5m	55x36x28	3	17.4kg	18kg	1050pcs	2205pcs
3x6m	55x36x28	2	14.8kg	15.3kg	700pcs	1470pcs

Tent

Anti-UV available
Water proof coating with over 1000ml water column
Aluminum frame(steel optional)
Best color fastness
Professional confection
Size:150x150cm,200x200cm,
300x300cm,300x450cm,
300x600cm



Tent Accessories

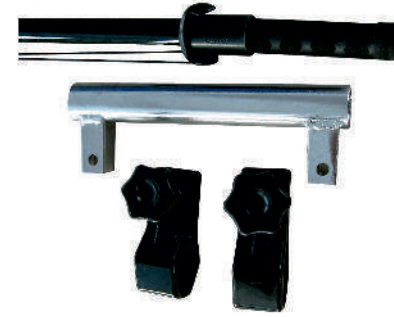

Flag holder



Folding table with bag(0.6x0.6m)



Folding table with bag(1.1x0.6m)



Half wall



Iron weight



Carry bag



Spikes and ropes(4pcs/bag)



Full wall

Display system - POP UP wall

Pop up walls for all kind of events .Our pop up Us's frame is made of high quality aluminum material! It has large display screen also it is easy for installation and disassembly. This product is very suitable for bringing out your message big!



3 sizes

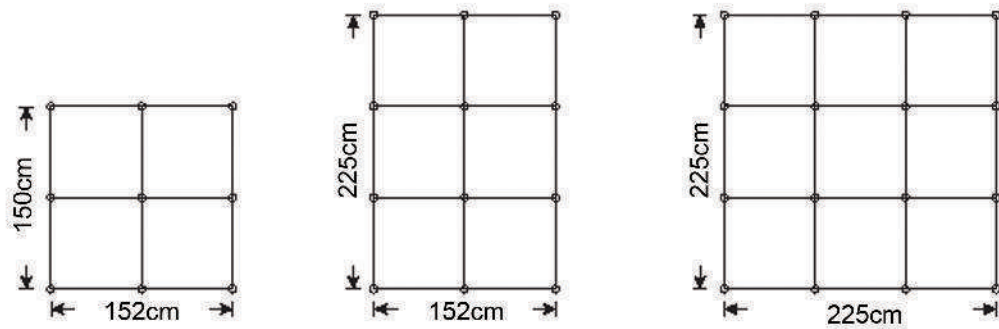

Instruction sheet

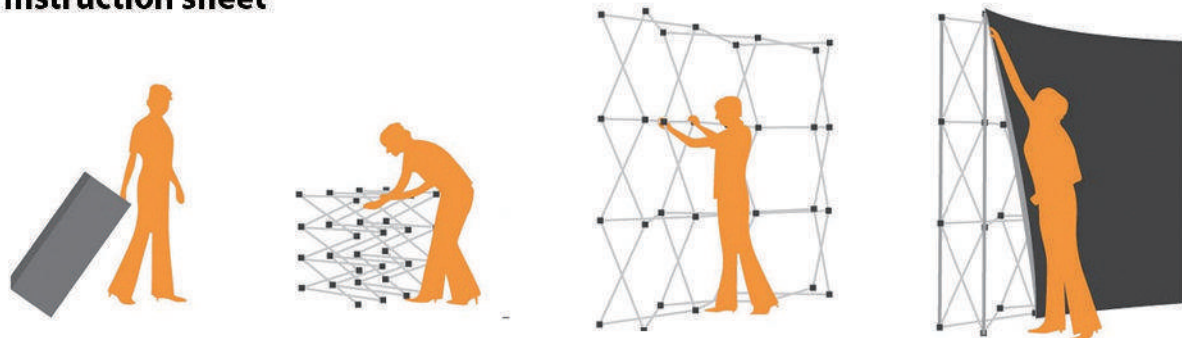

Packing				
Graphic size	N.w.(kg)	G.w.(kg)	Pcs/ctn	Carton size
152x150cm	4	6	1	25x25x83cm
152x225cm	7	8.5	1	30x25x83cm
225x225cm	9.5	11	1	30x30x83cm

Backdrop-walls

A new design of walls. A new view for your messages .Backdrop wall is widely used for indoor & outdoor advertisement, trade show, events, and all kind of promotions. It is light , easy and quick to install.

U-Shape



graphic size:
W314cm X H228cm
W414cm X H228cm



4 shapes to choose

S-Shape



graphic size:
W324cm X H228cm
W424cm X H228cm

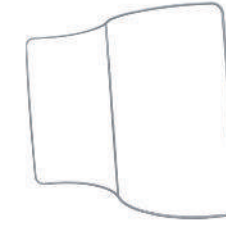

Light to carry

C-Shape



graphic size:
W320cm X H228cm
W420cm X H228cm

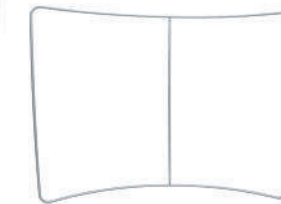

Easy installation

High quality & good price

Straight line



graphic size:
W310cm X H228cm
W410cm X H228cm

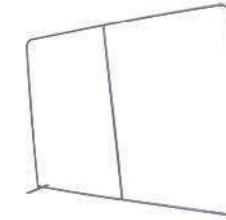

Product Series	Frame Size (mm)	Graphic size (mm)	pcs /ctn	G.W. (kgs)	Packing Size(cm) /ctn (cm)
U-Shaped	3000*2280	3000*2280	1	7.3	27*27*80
	4000*2280	4000*2280	1	8	27*27*80
S-Shaped	2997*2280	3140*2280	1	5.5	27*27*80
	4000*2280	4000*2280	1	6	27*27*80
C-Shaped	3000*2280	3000*2280	1	6	27*27*80
	4000*2280	4000*2280	1	7	27*27*80
Straight wall	2922*2280	2922*2280	1	7.5	27*27*76
	4000*2280	4000*2280	1	9.6	37*37*74

Display system



Our several Display Systems offer the opportunity for you to make a perfect presentation of your advertising.

By the decent and precious design your message gets the attention of the viewers in a pleasant way.

We offer many kinds of Display Systems. You can find one to meet your need.

Display system













We offer the competitive display solution to match any budget and calculation for any marketing campaign.

Banners can be changed quickly which gives you high flexibility.

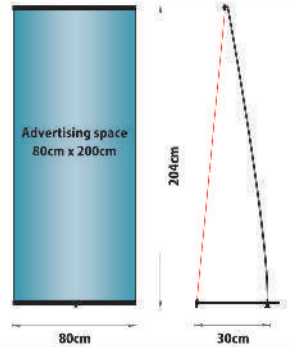
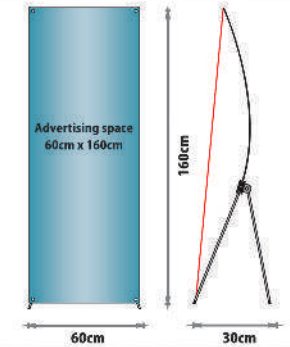
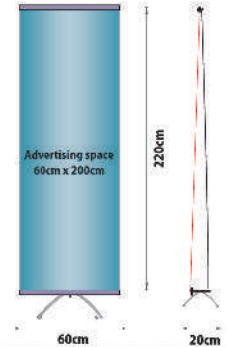



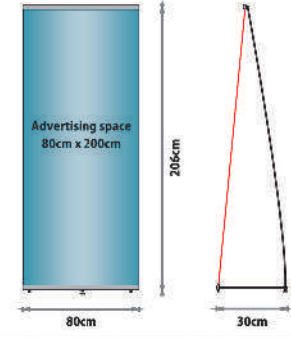
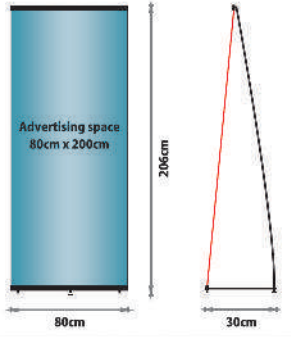

Double sided exhibition display stands can be set up in 60 seconds, It is a perfect display stand to show your advertising message on two sides.





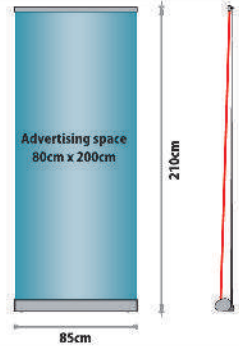
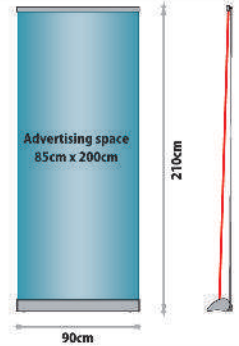
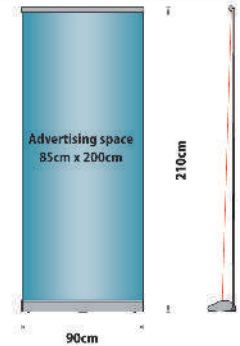

	Easy Stand	X-Stand	AR
Set components			
Set components	 <ul style="list-style-type: none"> -Steel/Plastic feet -Advertising print -Fiberglass pole -Clamping rails -Carrying case 	 <ul style="list-style-type: none"> -Plastic rack -Fiberglass stiffed bars -Advertising print 	 <ul style="list-style-type: none"> -Aluminium feet -Advertising print -Clamping rails -Carrying case
Measurements	 <p>Advertising space 80cm x 200cm</p> <p>204cm</p> <p>80cm 30cm</p>	 <p>Advertising space 60cm x 160cm</p> <p>160cm</p> <p>60cm 30cm</p>	 <p>Advertising space 60cm x 200cm</p> <p>220cm</p> <p>60cm 20cm</p>
specification	<ul style="list-style-type: none"> -Steel/Plastic feet -Pole made of Fiberglass -Clamping rails made of plastic -Color:Black 	<ul style="list-style-type: none"> -Plastic rack -Fiberglass stiffed bars -Color:Black 	<ul style="list-style-type: none"> -Aluminium foldable feet -Clamping rails made of Aluminium with plastic caps
packing	<ul style="list-style-type: none"> - In carrier bag: - 4x80cm -Set weight:0.8kg 	<ul style="list-style-type: none"> - In carrier bag: - 4x110cm -Set weight:0.5kg 	<ul style="list-style-type: none"> - In carrier bag: - 6x8x97cm -Set weight:1.5kg

	L-Stand Classic	L-Stand Premium
Set components		
Set components	 <ul style="list-style-type: none"> -Aluminium feet -Advertising print -Aluminium pole -Clamping rails -Carrying case 	 <ul style="list-style-type: none"> -Iron Feet -Advertising print -Glassfiber poles -Clamping rails -Carrying case
Measurements	 <p>Advertising space 80cm x 200cm</p> <p>206cm</p> <p>80cm 30cm</p>	 <p>Advertising space 80cm x 200cm</p> <p>206cm</p> <p>80cm 30cm</p>
specification	<ul style="list-style-type: none"> -Aluminium feet -Three parts pole made of Aluminium -Clamping rails made of Aluminium with plastic caps - Color:Silver 	<ul style="list-style-type: none"> -Iron Feet -Three parts pole made of Fiberglass -Clamping rails made of Aluminium with plastic caps - Color:Black
packing	<ul style="list-style-type: none"> - In carrier bag: - 11.5x93cm -Set weight:2.4kg 	<ul style="list-style-type: none"> - In carrier bag: - 11.5x93cm -Set weight:3.3kg

Display system

	Roll Up Classic	Roll Up Premium	Roll Up deluxe
Set components			
Set components	 <ul style="list-style-type: none"> -Aluminium base -Advertising print -Aluminium pole - Clamping rails - Carrying case 	 <ul style="list-style-type: none"> -Aluminium base -Advertising print -Aluminium pole - Clamping rails - Carrying case 	 <ul style="list-style-type: none"> -Aluminium base -Advertising print -Aluminium pole - Clamping rails - Carrying case
Measurements	 <p>Advertising space 80cm x 200cm</p> <p>85cm</p> <p>210cm</p>	 <p>Advertising space 85cm x 200cm</p> <p>90cm</p> <p>210cm</p>	 <p>Advertising space 85cm x 200cm</p> <p>90cm</p> <p>210cm</p>
specification	<ul style="list-style-type: none"> -Aluminium base -Two parts pole made of Aluminium - Clamping rails made of Aluminium with plastic caps 	<ul style="list-style-type: none"> -Aluminium base with sidecaps color chrome -Two parts pole made of Aluminium - Clamping rails made of Aluminium with plastic caps 	<ul style="list-style-type: none"> -Aluminium base -Two parts pole made of Aluminium - Clamping rails made of Aluminium with plastic caps
packing	<ul style="list-style-type: none"> - In carrier bag: - 13x13x90cm -Set weight:3.1kg 	<ul style="list-style-type: none"> - In carrier bag: - 13x14x91cm -Set weight:5.4kg 	<ul style="list-style-type: none"> - In carrier bag: - 6x27x94cm -Set weight:7.2kg

Display system

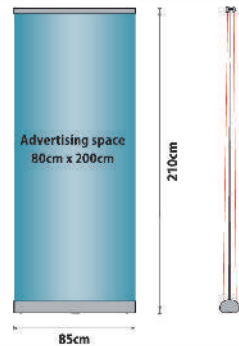
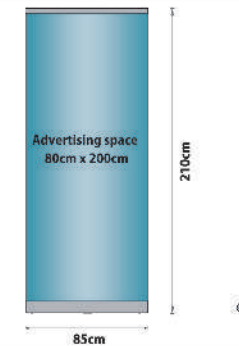
	Roll Up deluxe doublesided	Roll Up Premium doublesided
Set components		
Set components	 <ul style="list-style-type: none"> -Aluminium base -Advertising print -Aluminium pole - Clamping rails - Carrying case 	 <ul style="list-style-type: none"> -Aluminium base -Advertising print -Aluminium pole - Clamping rails - Carrying case
Measurements	 <p>Advertising space 80cm x 200cm</p> <p>85cm</p> <p>210cm</p>	 <p>Advertising space 80cm x 200cm</p> <p>85cm</p> <p>210cm</p>
specification	<ul style="list-style-type: none"> -Aluminium base -Two parts pole made of Aluminium - Clamping rails made of Aluminium with plastic caps 	<ul style="list-style-type: none"> -Aluminium base with sidecaps color chrome -Two parts pole made of Aluminium - Clamping rails made of Aluminium with plastic caps
packing	<ul style="list-style-type: none"> - In carrier bag: - 10x24x88cm -Set weight:5.8kg 	<ul style="list-style-type: none"> - In carrier bag: - 13x23x87cm -Set weight:5.8kg

A-Frame(DAF)

Shapely and dynamic design for a pleasant kind of marketing.
Your advertising can be seen on both sides, which means maximum attention is guaranteed.
A-Frames, a new kind of marketing tool.



It can be assembled in seconds and easy to carry.
Every A-Frame comes with a suitable bag.



A-Frame(DAF)

A-Frame/Pop Out	
Size small	 <p>A-frame 70x145cm Packing details: PCS/CTN:15 Carton Size (cm):64x64x25 N.W(kg):21 G.W(kg):22.2 20' Container:3600pcs 40' Container:7200pcs</p>
Size medium	 <p>A-frame 80X180cm Packing details: PCS/CTN:15 Carton Size (cm):80x80x25 N.W(kg):28.5 G.W(kg):29.9 20' Container:2340pcs 40' Container:4680pcs</p>
Size big	 <p>A-frame 100X230cm Packing details: PCS/CTN:15 Carton Size (cm):100x100x25 N.W(kg):42.75 G.W(kg):44.5 20' Container:1500pcs 40' Container:3000pcs</p>

Each A-Frame / Pop Out system is delivered with four metalhooks to fix on the ground and a practical transportation bag.

Cube Chair



Outstanding Advertising Effect, branding promotion
 - Suitable for many occasions : Clothes Shop, Shoe Shop, Hair Salon, Show Fair... wherever you like to show your ideas
 - A decorative cube, an occasional seat
 - Lightweight, quick installation, easy to carry and store



Specification:
 Size: 40x40x40cm. Custom made sizes
 Cover is closed with either zipper or velcro.
Material:
 - Fabric Cover: Display fine 200g/m², 100% knitted polyester, replaceable
 - Stuffing: High-elastic sponge

Carton Size (cm)	PCS/CTN	N.W.(kg)	G.W.(kg)	20' Container	40' Container
42x42x42	1	1.78	2.4	330	660

Telescopic Pole(DTP)

Telescopic Pole Water-base(DTP-W)



Telescopic Pole U-feet(DTP-U)



Packing details:
 in carton :12x36x177cm&in carton :40x44x85cm
 16.30 kg/pcs,1pc/2 cartons
 G.W :18kg/carton
 N.W: 16.30 kg/carton
 In 20' container: 123 pcs,246 cartons
 In 40' container: 220 pcs,440 cartons



Packing details:
 in carton :12x36x177cm
 9 kg/pcs,1pc/ carton
 G.W :10kg/carton
 N.W: 9 kg/carton
 In 20' container: 363 pcs,363 cartons
 In 40' container: 649 pcs,649 cartons

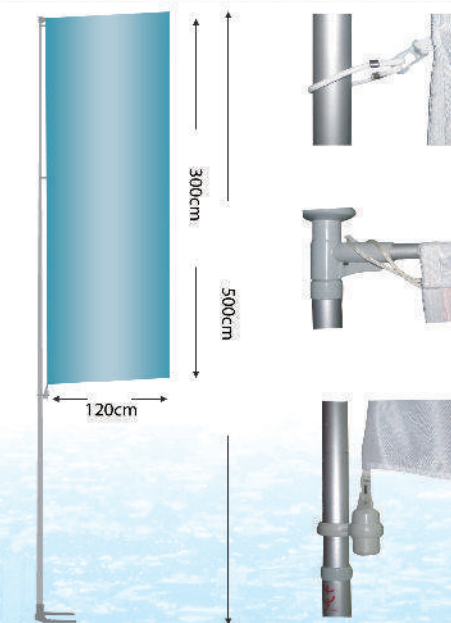
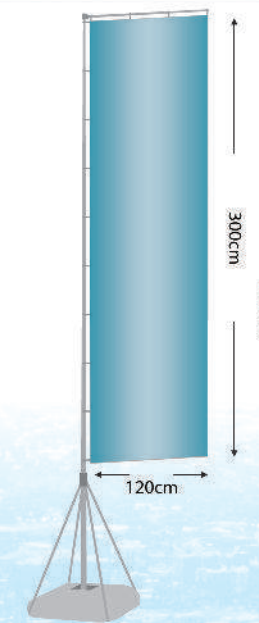

Set components

Measurements

Accessories



velcro and fleece



Webbing with double seam extra strong sling

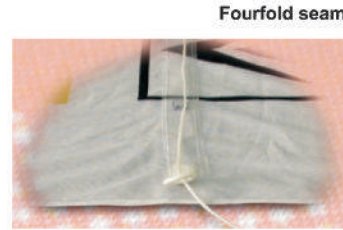

Fourfold seam

Ring safety for outdoor banner



metal safety hooks



Stitches and hem stitches

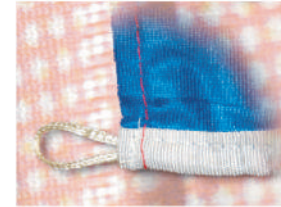

rope(white) extra strong for long time outdoor use



eyelet metal silver color golden color

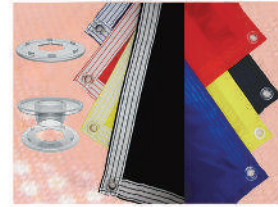

eyelet plastic transparent

Ready Made:
We fulfill all your wishes - just let us know and we will satisfy your needs.

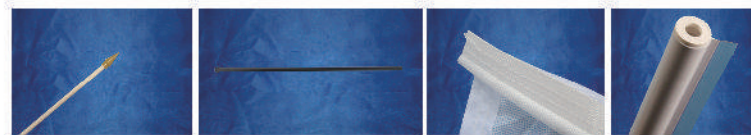
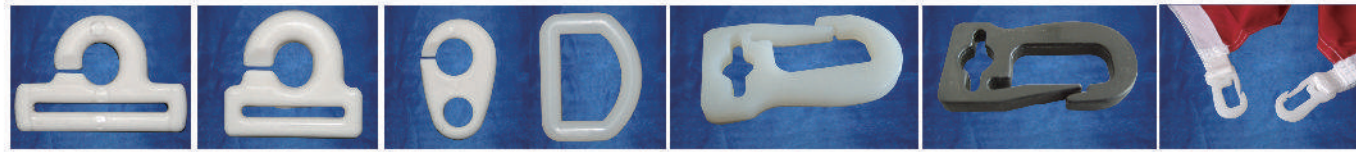

Metal tube
Color available:
silver/white/black

Production

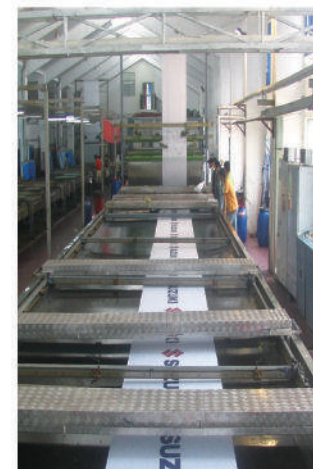

Fabric	Weight	Material	
stormflag	90g	100% knitted polyester	
	110g		
	120g		
	135g		
	150g		
	180g		
shining stormflag	125g/110g		
display fine	110g		
	130g		
	160g		
	200g/300g		
satin	125g		
	160g		
	200g		
longlife	120g		
airtex	115g		
tablebanner complex	300g		
tableflag fabric	50g		100% woven polyester
shipflag	160g		
fanflag	80g		
oxford	180g/220g		
oxford with PV coating	300g		100%nylon
100%nylon	110g		
nonwoven	135g	nonwoven	
PVC	460g/260g	PVC	
PVC mesh	370g		
display elastic	260g		
Canvas	200g		
Block out fabric	200g		
Oxford PVC coated	400g		

.....and much more is available !



First class machine! First class team!
First class Fabric!



Advanced management guarantee
German, Swiss, Italian, Austria
quality management.



Quick delivery time! CQ Textile makes
your business more successful!

After-knitting Fabric Treatment



Quality Inspection



Fabric Structure

Knitted, 100% Polyester 90gsm-200gsm Max width: 500cm

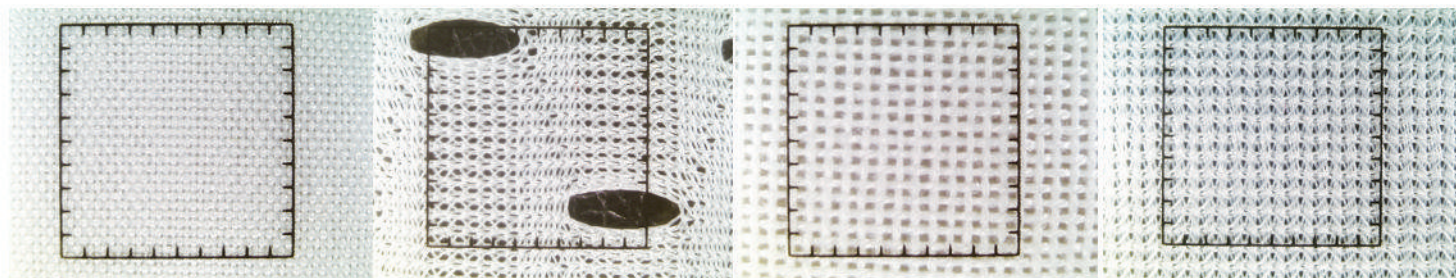

fanflag

airtex

shipflag

stormflag

Packing	
100m per roll	
Width	Rolls in 20' container
105cm	520
125cm	450
155cm	365
185cm	320
205cm	280
Treatment Available on Fabric	
Anti-static for digital printing	Fire proof with B1 or M1
Waterproof Coating	UV protection
Width of Fabric	
customerized, max 5m	

Printing Processes

Information about Data Handling and Data Submission

Our sales representatives will advise you and coordinate with you the best way to produce your desired product. We will offer you the highest quality and the most economical way and manufacture your order according to your wishes in screen printing or in digital printing.

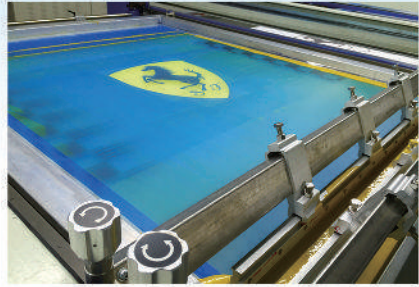

Screenprinting: In the screen printing process, vector images, such as logos, fonts and the equal surfaces, can be produced in spot colors. Image motifs are printed in raster. Vector graphics and image motifs can be produced in combination with 4c rasters and spot colors. Our screen printing systems allow up to 10 single colors to be printed at the same time.

Digitalprinting: In digital printing process, vector images such as logos, fonts, equal surfaces and picture motifs are printed CMYK mode. Depending on your product and purpose, we have the possibility to offer you our digital prints as transfer-, direct-sublimation-, direct-disperse-, or UV printing.

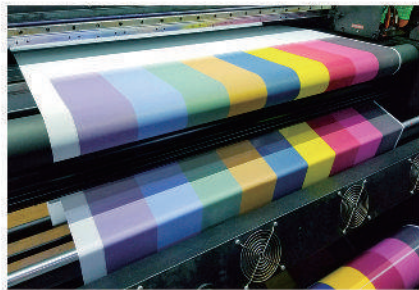

Resolution: The resolution depending on the application and viewing distance of the images. Different resolutions are possible.

For **screen printing** we should have for the included images a resolution between **300 dpi** and **500 dpi** in scale 1:10 depending on the raster resolution used in the print.

For **digital printing** we should have for the included images a resolution of **600 dpi** in scale 1:10.

Fonts: Please convert all fonts in your file into paths or curves. Alternatively, you can send us the used font as the original True type font in an extra folder. (PC compatible)

Layout: The **bleed** in the format should be at least **30 mm**. That means in the file in scale 1:10 the bleed must be 3 mm. For a hemstitch we have calculated correspondingly more bleed.

The **safety distance** of important motif elements, such as logos or lettering should be **25 mm** on all sides. This is to avoid problems when the borders are sewed or pinched.

Line thickness: The minimum line thickness is **0.6 mm** in the positive- and **1.5 mm** in the negative print.

Transparencies: Please do not use spot colors in your files in combination with transparencies. This can lead to undesirable results.

Overprinting: Please do not create overprinting or trapping in your files.



Artwork Guidelines

Information about Data Handling and Data Submission

Dear Customer,

In order to ensure a fast and efficient processing of your order and to realize the best printing results, we ask you to carry out the following described procedures as accurate as possible.

File transfer: You have the following options to send us your data file.

- by email (up to 10 MB) to your corresponding project manager
- by FTP (access data please request)
- by Wetransfer
- by Disk CD, DVD or USB stick.
(Please label the disk clearly.)

Please create the folders with the clearly project name.

Programs: We prefer to work with the following programs.

- Adobe Illustrator
- Adobe Acrobat
- Adobe Photoshop
- Corel Draw

Other programs are also possible like Adobe Indesign, Freehand, QuarkXPress, ...
The latest versions are available by all programs.

Microsoft Office programs cannot be processed.

File formats: Layout: .ai, .cdr, .eps, .fh, indd, .pdf, .qxr
Pictures: .tif, .psd, .jpg

PDF: Please send us files in **PDF X4 Standard**.

Proportion: All files must be prepared in scale 1:10.

Pictures: If your design includes pictures save these separately.

Colors: If there are spot colors in your file, please define them according to **HKS K, Pantone C** or **RAL**.
The colored images create in your file in **CMYK** and the monochrome images create in **greyscale**.
If your data needs to be converted from RGB mode into CMYK mode, unwanted color changes are possible.

Color mode: CMYK in color profile ISO coated v2

Proof: Color-proof according to Fogra standard





ventas@nanimarketing.com 

+507 6747-1933 

+507 382-1800 

nanimarketing.com 